

Backers	
Description	Length
2x6 Backer	3' - 5 21/32"
2x6 Backer	3' - 5 21/32"
6' - 11 5/16"	

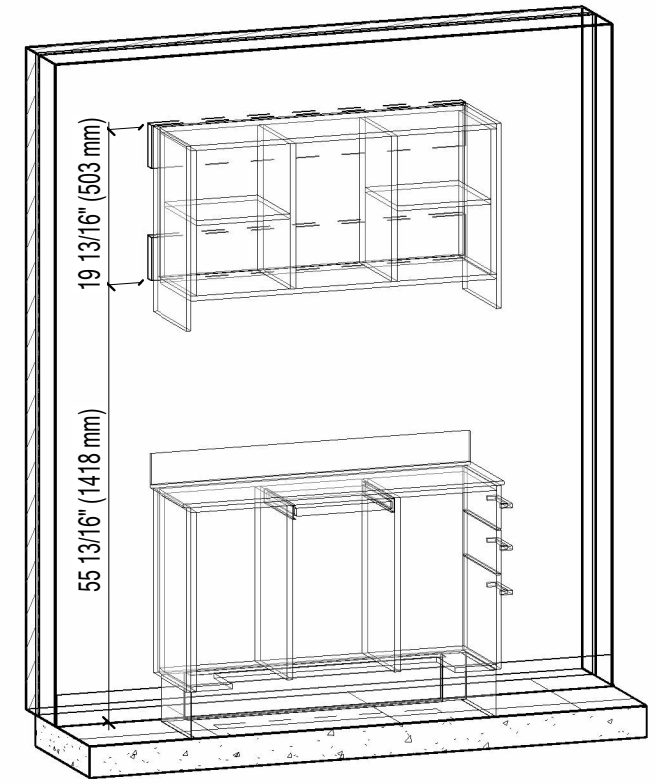

1 Utilities Location

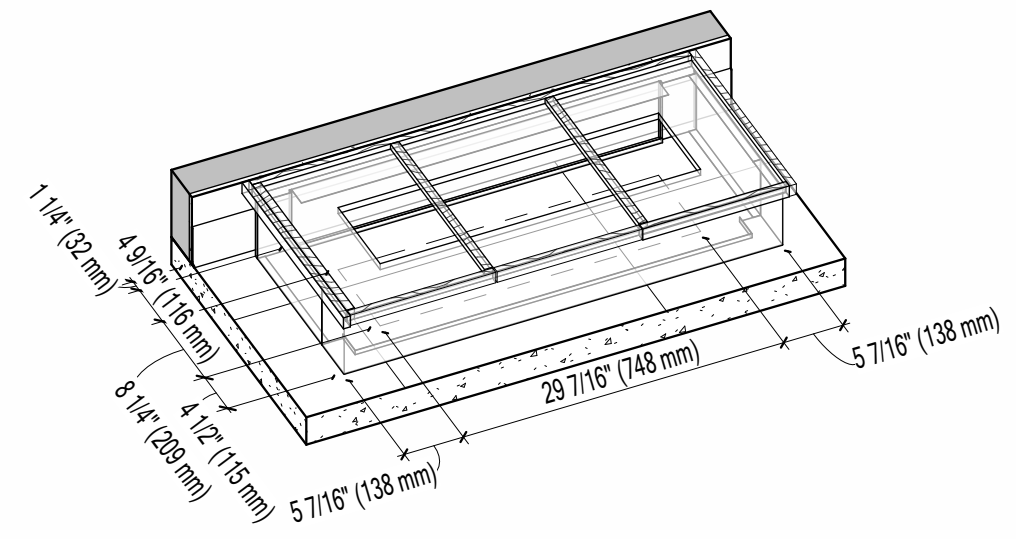

2 Utilities Access

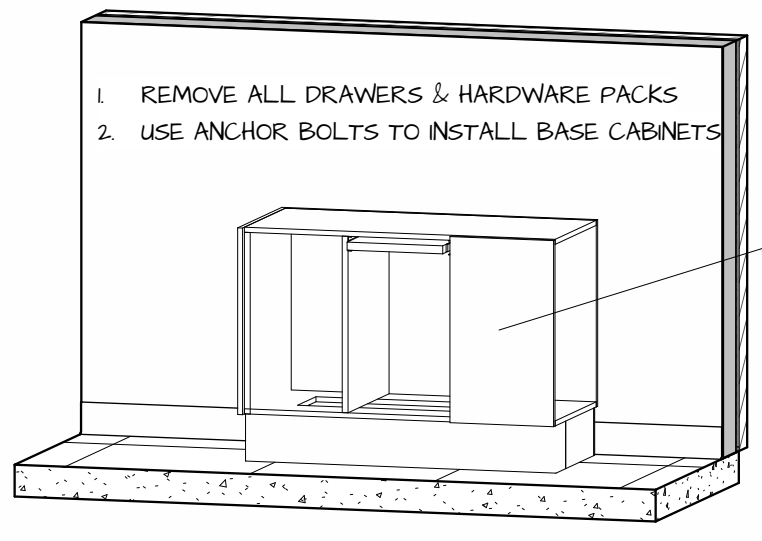

B Rear Console Base

2.1 Install Base Cabinets

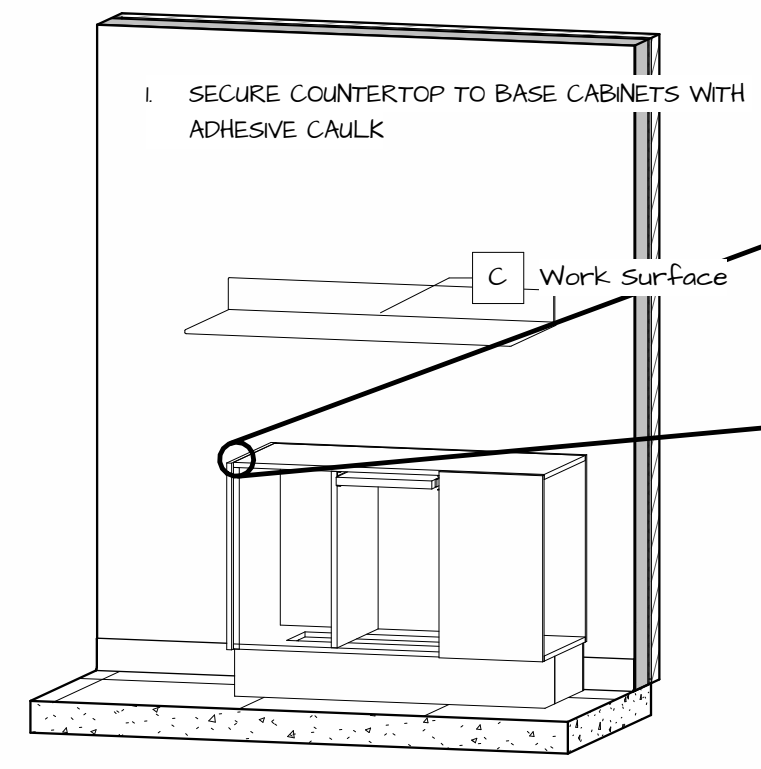

Adhesive Assembly

2.2 Install CounterTop

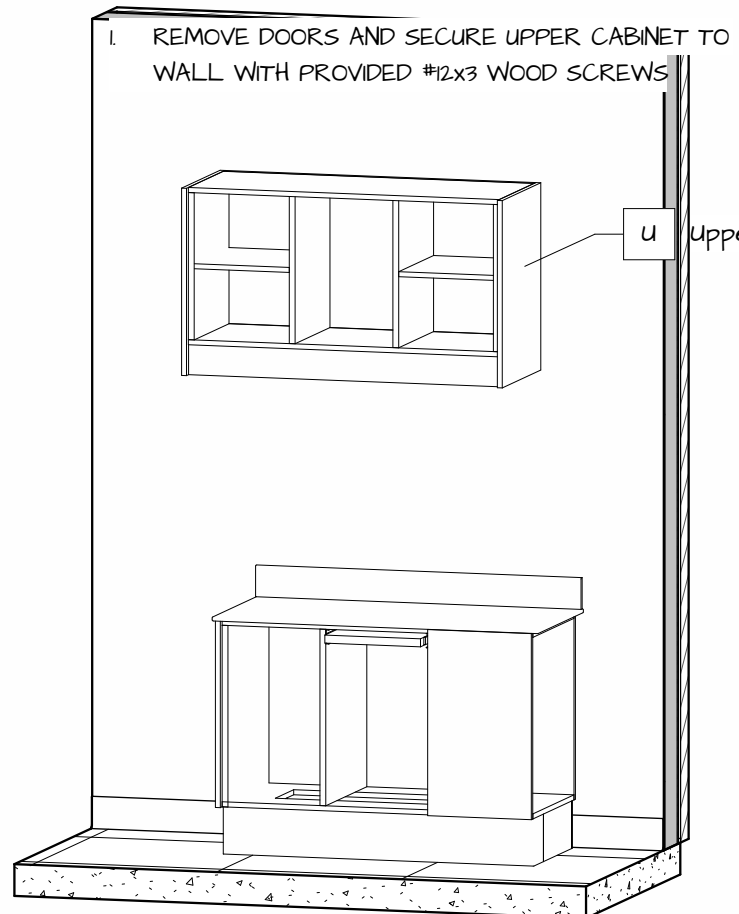

u Upper Cabinet

2.3 Install Upper Cabinets

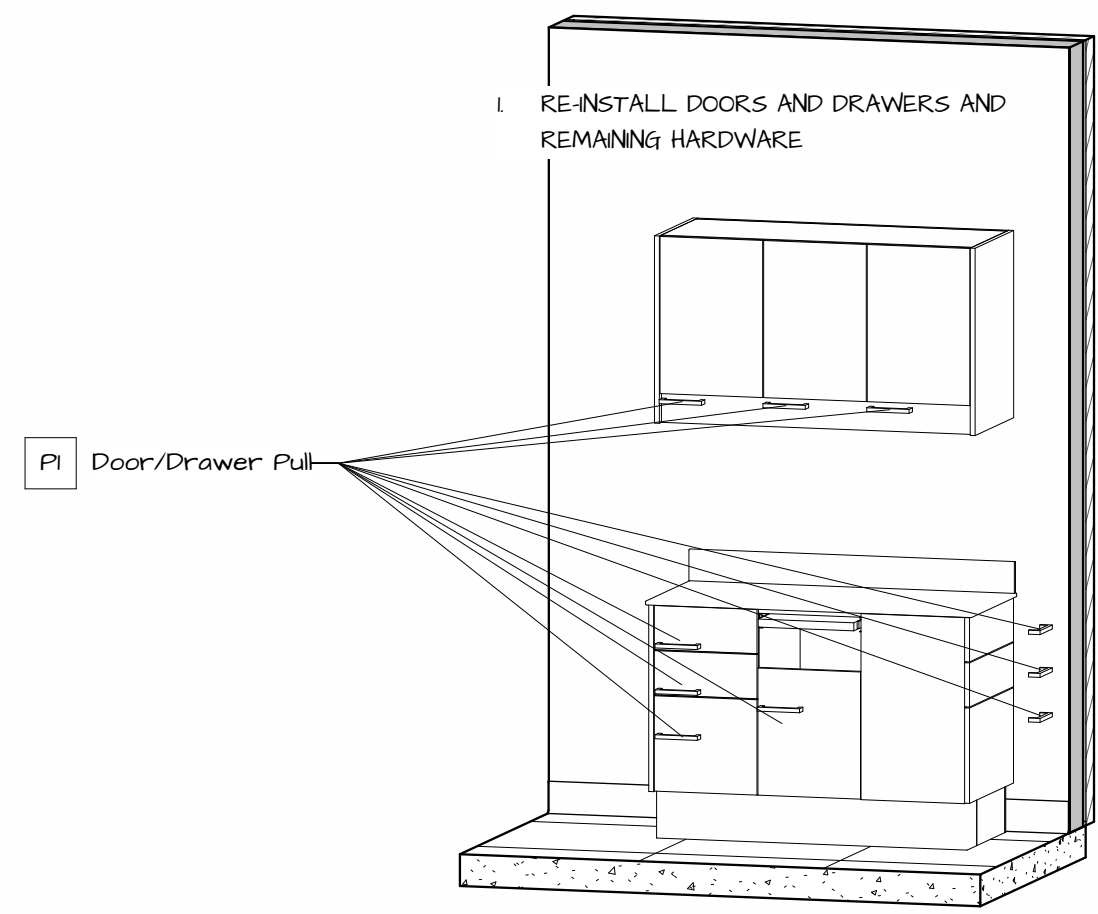

Pl Door/Drawer Pull

2.4 Install Hardware

Packing List		
Mark	Description	Qty
	#12 3\" Wood Screws	4
	Anchor Bolts	4
	Strainer	1
	Tube of Caulk	1
B	Rear Console Base	1
C	Work Surface	1
Pl	Door/Drawer Pull	10
u	Upper Cabinet	1

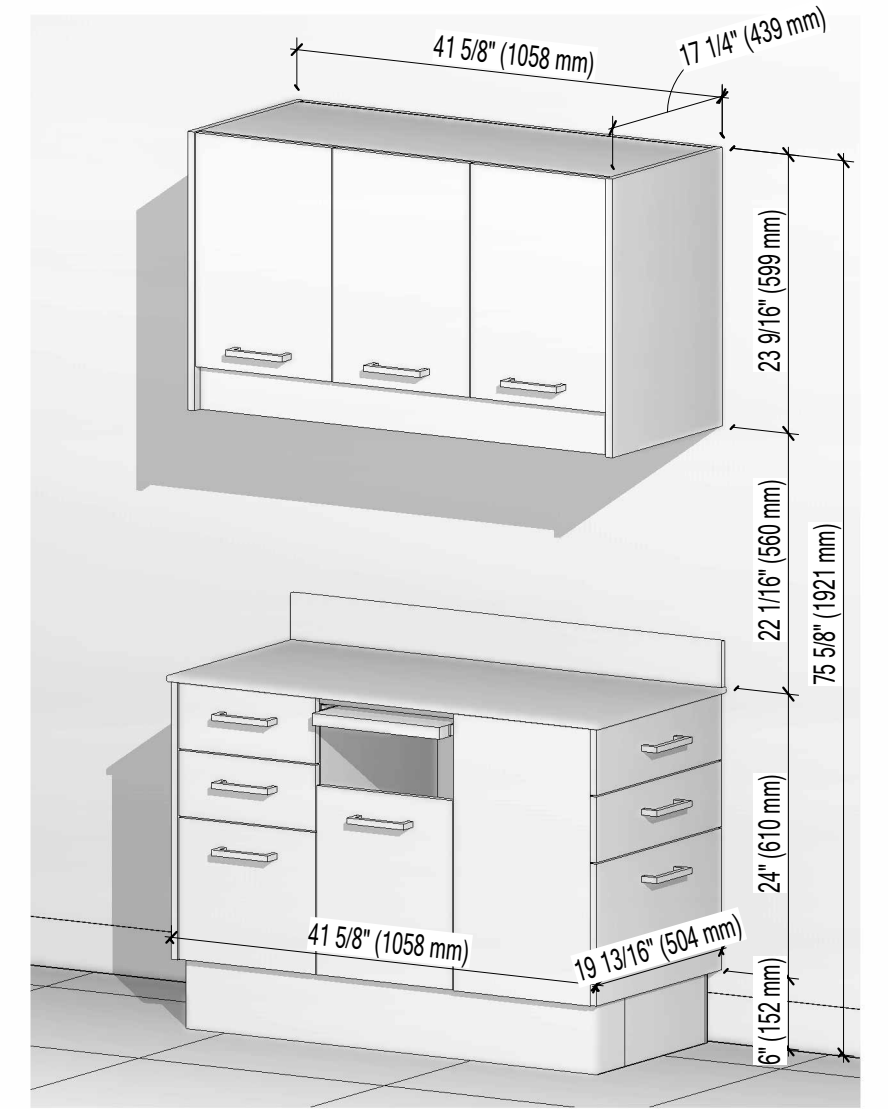

3 Final Installation View



Installation Drawing		Prepared For: NOVA Solutions Inc.
LINEA		
Project	REAR TREATMENT CENTER	I-1
Item #	ALRTC B15-H00-U12	
Drawn by:	Justin Martin	09/15/24
		Rev. 1